

# Operator's manual



**Basic machine  
Park Ranger 2150**

# Introduction

## Dear Customer

### **Congratulations with your Egholm product**

The Park Ranger 2150 offers a very flexible way of maintaining outdoor areas.

### **Optimal use of your Park Ranger 2150**

To ensure optimal performance of your Park Ranger 2150, please read this manual carefully before using the machine. Failure to do so can result in personal injury and damage to the machine.

### **Safety**

The Park Ranger 2150 is equipped with various devices to ensure optimal operational safety both for the user and their surroundings. We ask you to pay particular attention to section 1.1. Safety. The machine must only be serviced by professionals.

The Park Ranger 2150 is designed only for use by professionals. On delivery, the user will receive thorough training to become a competent operator.

Do not lend it to anyone who has not been thoroughly trained and who has not read this manual carefully.

The operator's manual should be considered a permanent part of the machine and must remain with the machine if sold.

### **Warnings**

Some items in this operator's manual are marked with this warning symbol.

The warning indicates areas where extra care has to be taken to avoid personal injury or damage to the machine and its accessories. The warning also shows what you should pay special attention to.



### **Reservations**

As it is the Egholm policy to make continuous improvements, we reserve the right to alter the specifications and equipment at any time without notice. Egholm accepts no liability for errors or omissions in the operator's manual.

### **Contact us**

Should you have questions of any kind regarding your Egholm product, please do not hesitate to contact Egholm.

Best regards

Egholm A/S · Transportvej 27 · DK-7620 Lemvig

T. +45 97 81 12 05 · F. +45 97 81 12 10

E-mail: [info@egholm.dk](mailto:info@egholm.dk) · [www.egholm.eu](http://www.egholm.eu)

# Contents

Introduction .....	5
General information .....	7
1.1 Safety .....	7
1.2 Attachments .....	9
1.3 EC Declaration of Conformity .....	10
1.4 Technical data .....	11
1.5 Access to the cab .....	14
1.6 Steering column .....	16
1.7 Operational features .....	20
1.8 Fitting a cab (optional) .....	23
1.9 Operating panel, cab (optional) .....	24
1.10 Removable load carrier (optional) .....	25
1.11 Driver's seat .....	26
1.12 Oil cooler cover .....	26
1.13 Fuses and main switch .....	27
1.14 Fuses and relay overview .....	28
Operator's manual .....	31
2.1 Daily checks before start-up .....	31
2.2 Starting, operating and stopping .....	33
Service and Maintenance .....	36
3.1 Daily maintenance .....	36
3.2 Lubrication .....	37
3.3 Service and maintenance chart for the Park Ranger 2150 .....	38
3.4 Hydraulic system .....	40
3.5 Engine maintenance .....	41
3.6 Fuel .....	43
3.7 Radiator .....	45
3.8 Air filter .....	46
3.9 Windscreen washer liquid .....	46
3.10 Battery .....	47
3.11 Fan belt .....	48
3.12 Articulated joint .....	48
3.13 Towing .....	48
3.14 Tire change .....	49
Conditions .....	51
4.1 Warranty .....	51
4.2 Complaints .....	52
4.3 Disposal .....	52
Wearing parts .....	54
5.1 Wearing parts – Park Ranger 2150 .....	54
Notes .....	56

# Introduction

**Honest  
Machines**

## **The Park Ranger 2150 utility machine**

The Park Ranger 2150 is an Egholm utility machine with a complete range of special attachments designed to allow you to perform outdoor maintenance work all year round. Sweeping and vacuuming in spring and autumn, mowing grass and lawn-edge cutting in the summer, and sweeping snow, and spreading gravel and sand in the winter.

## **Easy attachment changeover**

Attachments can be changed quickly and easily in less than four minutes.

# General information

**Honest  
Machines**

# General information

## 1.1 Safety



### **Make sure no-one is standing close to the machine while it is in use**

Make sure that no one is near the machine while it is in use as there is a danger of crushing.



### **NB**

As it is articulated, the rear end of the machine swings out when turning. Make sure that no one is standing near the machine while it is in use. (Picture 1)



### **Turn the steering wheel carefully**

The Park Ranger 2150 is articulated and the steering mechanism is extremely responsive. (Picture 2)



### **Avoid accidents with battery acid and gases**

Batteries contain explosive gases and acid. Please take the greatest care when handling batteries. (Picture 3)



### **Avoid accidents with exhaust fumes**

Exhaust fumes can cause illness or even death. If the engine is to run in an enclosed room, the exhaust fumes must be led outside – using an exhaust hose, for example. If there is no ventilation system in the room, the doors and windows must be left open to allow fresh air to enter.



### **Avoid roll-overs**

Do not drive the machine in places where there is a risk that it may slide, tip or roll. Do not drive on slopes with an incline of more than 10°. (Picture 4)

**Keep children away from the machine when the engine is running**

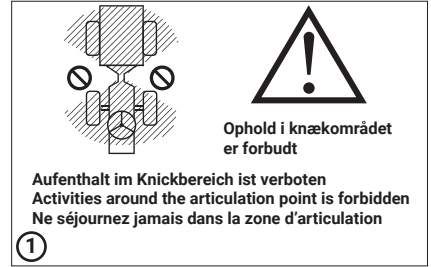

Prevent people from standing in the working area



Articulated joint



Battery

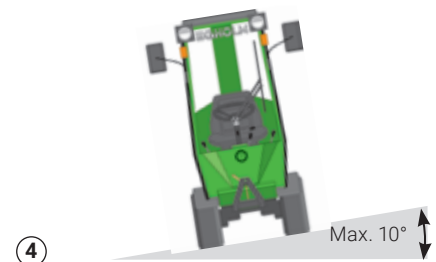

Do not drive on slopes with an incline of more than 10°

# General information

## 1.1 Safety - continued

### Avoid crushing fingers

Keep your hands and fingers away from areas where there is a danger of crushing.

### The A-frame

Take care not to catch your fingers in the A-frame for the various attachments. (Picture 1)

### Exhaust pipe

Make sure not to touch the exhaust pipe as this becomes very hot when the machine is operating. (Picture 2)

### The Engine

Caution! All components in the Engine can become very hot!

### Fan belt

Make sure not to catch your fingers in the fan or the fan belt. (Picture 2)



### Avoid damage to your hearing

Always wear approved ear protectors when using the machine. (Picture 3)



### Other hazards

There may be other circumstances and situations than those mentioned above where it may be dangerous to use the Park Ranger 2150.



### Maintenance

Before carrying out servicing and maintenance please make sure to pull the hand brake, stop the engine and turn off the main switch of the machine.

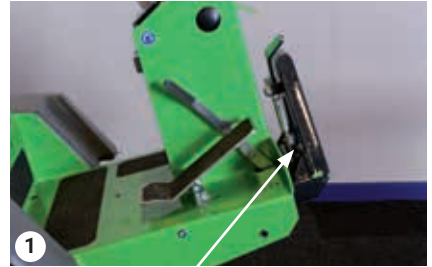

Avoid crushing fingers



Exhaust pipe

Fan belt



③

Use approved hearing protection



## 1.2 Attachments

Park Ranger 2150 is designed to work with the following attachments:

<b>Attachments</b>	<b>Type</b>
Suction Sweeper - Front brushes	FK22150
Suction Sweeper - Third brush	HS1
Suction Sweeper - Hopper	FS2150
Suction Sweeper - Hopper	FS2150 II
Mulch Mower 1200	LM1200
Mulch and Rotary Mower 1000	LM1000
Rotary Mower for Grass Collecting 1000	LMC1000
Hopper for Grass Collecting	GC500
Lawn Edger	22VKS1
Flail Mower / Verticutter	21SLK
Leaf Suction Unit	LS100U
Hedge Trimmer	HK 1300 MINI / 2200
Tipping Shovel	VS200
Tipper Trailer	ST2150
All Purpose Tipper Trailer	TV600
Environmental rake	MR1100
Load carrier	ST2150
Snow Sweeper	21SK1205
Dozer blade	21DZ1305
Snow V-blade	FS1300VLE
Snow Blower	SN100
Salt and Sand Spreader	2150SG

There is an operator's manual for each attachment.

Operation with these attachments must follow the instructions outlined in the relevant operator's manual. Do not operate the Park Ranger 2150 with the attachment unless all instructions have been followed.

# General information

## 1.3 EC Declaration of Conformity

Manufacturer: **Egholm A/S**  
Address: **Transportvej 27 · DK-7620 Lemvig**  
Telephone: **+45 97 81 12 05**

hereby declares that

The machine: **Park Ranger 2150 B1**  
Type: **UHM 2150B1 XX A (year of manufacture)**  
**A XXXXX (serial number)**

· has been manufactured in conformity with Directive 2006/42/EU

Any alteration, rebuilding or addition of implements, accessories or other equipment not manufactured by Egholm automatically results in the cancellation of type approval, CE approval, any other approval, as well as any warranty on machine and attachments.

Unless otherwise agreed in writing between the operator, customer and Egholm, Egholm is the data originator (data originator) of all data generated by the machine and attachments during use.

Person authorized to compile the technical documentation:  
Rainer Flanz  
Egholm A/S  
Transportvej 27  
7620 Lemvig

Place: Lemvig

Date: \_\_\_\_\_

Signature:   
Rainer Flanz, R&D Manager

## 1.4 Technical data

### Dimensions

Length (L) .....	2,225 mm
Width (W) .....	1,015 mm
Height with cab .....	1,935 mm
Height without cab .....	1,210 mm
Max. speed .....	16 km/h

### Weight

Weight .....	485 kg
Max. permitted weight for:	
Utility machine .....	1,300 kg
Machine and trailer without brakes .....	1,750 kg
Machine and trailer with overrunning brakes .....	2,650 kg
Trailer without brakes .....	750 kg
Trailer with overrunning brakes .....	1,500 kg
Permitted axle load, front .....	740 kg
Permitted axle load, rear .....	740 kg

### Tyres

Tyre size .....	18 x 9.5-8
Tyre pressure .....	1.6 bar or 24 psi

### Engine

Type/manufacturer .....	Perkins Diesel
Type .....	403J-11
Engine power .....	25,7Hk - 18,9kW at 2800 rpm
Cylinders .....	3
EU Norm .....	Stage V
Please refer to the engine operator's manual for additional technical data	

### Fuel

Fuel .....	Diesel
Fuel tank capacity .....	20 l diesel
At 2,400 rpm .....	approx. 2.8 l/h
At 3,400 rpm .....	approx. 4.6 l/h

# General information

## 1.4 Technical data - continued

### Lubricating system

Lubricating system	Pressure-lubricating system with filter
Lubricants	Engine oil: approx. 3 l, synthetic 5W-40 API CF, CF-4, CG-4,CH-4
Air filter	Dry, replaceable element filter
Cooling system	Liquid coolant

### Electrical system

Starter system	Electric starter with glow plugs
Charging system	Generator
Charging capacity	12 volt, 65 amp
Battery	12 Volt, 44 AH

### Hydraulic oil

Hydraulic oil, type	Texaco Rando HDZ 68
Tank capacity	15 l
Working pressure	Up to 180 bar

### Brakes

Operating brakes	Hydrostatic
Parking brakes	Mechanical

### Sound measurements

Running, Directive 2009/63/EF	78 dB(A)
Pass-by, Directive 2009/63/EF	80 dB(A)
Machine operator position, open windows, 2009/76/EF	85 dB(A)
Machine operator position, closed windows, 2009/76/EF	84 dB(A)

### Vibration test

Whole body, EN 13059	0.6 m/s <sup>2</sup>
Hand/arm, EN 13059	2.4 m/s <sup>2</sup>

### Turning radius

Park Ranger 2150 has an extremely small turning radius	1.5 m
--	-------

Information plate . . . . . Mounted on the right side of the front chassis

### Attention

Specifications may change without notice.

## 1.4 Technical data - continued

### **Cab**

#### **Falling Object Protective Structure - FOPS**

Park Ranger 2150 and its attachments do not operate when falling objects are a risk.

#### **Roll-Over Protective Structure - ROPS**

Tested according to Directive 86/298/EEC and fulfills OECD Code 7.

#### **Contact with harmful and unhealthy substances**

The classification of the cab is according to EN 15695-1 Category 1.

This type of cab does not protect you from harmful and unhealthy substances.

Park Ranger 2150 can NOT be used in environments, which require protection of the driver against harmful and unhealthy substances.

**Park Ranger 2150 electrical diagram og hydraulic diagram can be obtained by contacting Egholm authorized dealer**

# General information

## 1.5 Access to the cab

### Access without cab

Access to the driver's seat is from both sides of the utility machine.

Simply take a step up on the floor below the driver's seat. (Picture 1)

### Access with a cab

Access to the cab is from the right and left side door. The doors will open when you press the door handle button. (Picture 2)

To enter the cab, simply step directly in. (Picture 3)

To leave the cab, open the door with the inside door handle. The doors will open when you press the door handle down. (Picture 4)

Both doors can be used as an emergency exit.



Floor below the driver's seat



Outside door handle button



Cab floor



Inside door handle - Press down

# General information

## 1.5 Access to the cab - continued

### Opening the window

To open the window pull the small window button outwards and pull back the window handle. (Picture 1+2)

### Roof hatch

The cab is equipped with a roof hatch. The roof hatch will open when you push the handle upwards. (Picture 3)

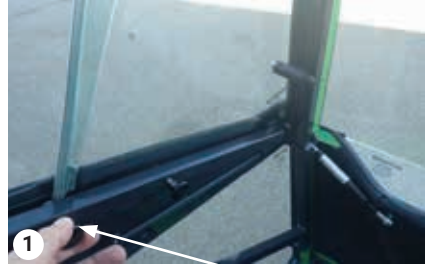

Pull out small button



Pull back handle for window to open



Roof hatch handle

# General information

## 1.6 Steering column



### **Steering column**

1. 12V Connector.
2. Horn switch.
3. Ignition key.



## 1.6 Steering column - continued

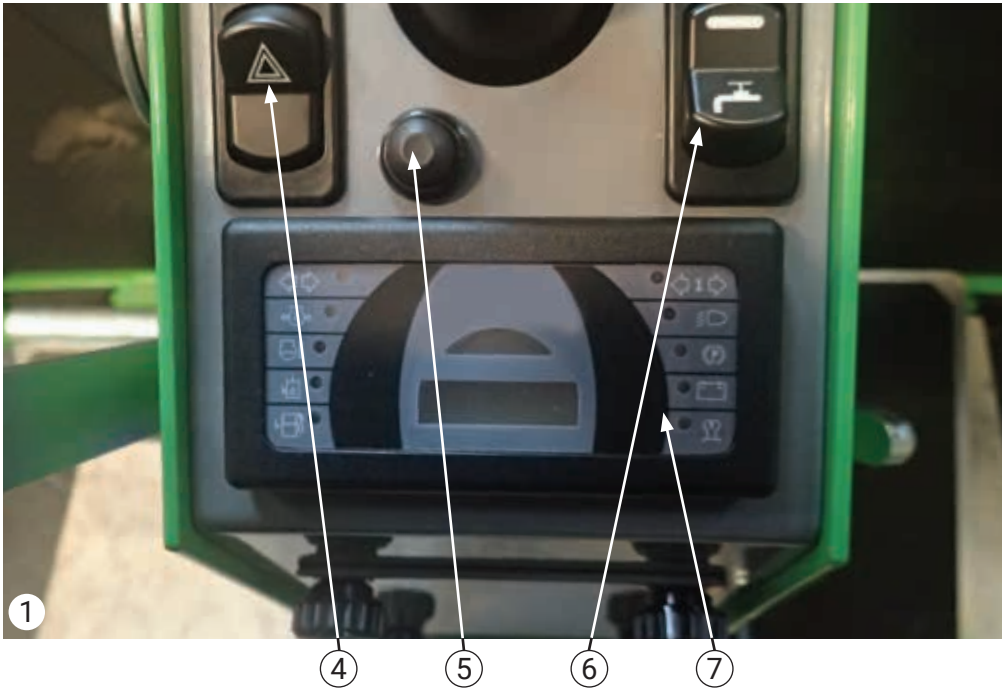

4. Hazard lights.

5. Instrument panel switch to switch between rpm and the timer.

6. Switch - electrical socket back.

7. Instrument panel.

# General information

## 1.6 Steering column - continued

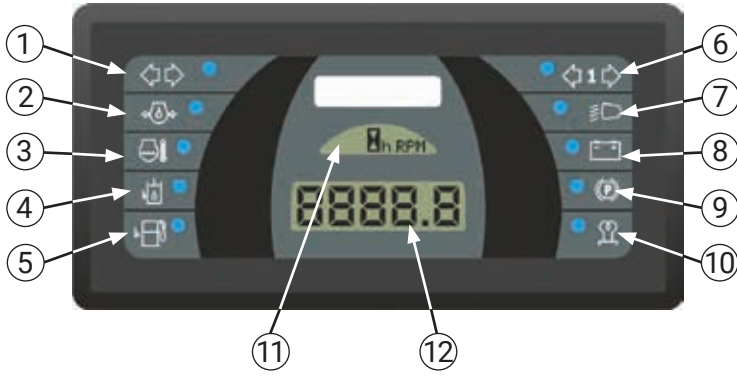

### Instrument panel

1. Indicator light - Green LED.  
Left and right indicator light.

**2. Oil alarm - Red LED.**  
**Stop driving, stop the engine immediately and check the oil level.**

Top up immediately if the oil level is low.

3. Temperature alarm - Red LED.  
Indicates that the engine temperature is too high. Switch off all attachments and let the engine run on half-power (rpm) for approx. 2 minutes. If necessary, clean the radiator cover.

4. Hydraulic oil - Red LED.  
Hydraulic oil level is too low: Hydraulic oil is required. Note that the alarm device may be activated when the temperature falls to under +5 °C.  
Check the oil level. If this is OK, restart the machine. The alarm must deactivate after 15 seconds.

5. Fuel tank indicator - Red LED.  
Lights up when there is less than five litres of fuel left in the tank. Enough for about 1½ hour drive.

6. Indicator for trailer - Green LED.  
Left and right indicator light for trailer.

7. Headlight indicator - Green LED.

8. Charging light - Red LED.  
Normally lights on ignition or when the engine starts. If the light stays on, stop the engine and find the cause. Check the generator belt.

9. Handbrake indicator - Red LED.

10. Pre-heater - Orange LED.

The pre-heater light is activated when the ignition key is turned, showing that the engine pre-heater is on. When the light goes out, the ignition key can be turned all the way to start the Park Ranger 2150.

11. Shows rpm or time (h).

12. Time/rpm/speed counter. Time shown on start-up. Switches automatically over to show rpm.

**Sound alarm activates in case of 2, 3, 5 and 8**

## 1.6 Steering column - continued



### **Steering column**

1. Throttle.
2. Handbrake.
3. Indicator light switch/stalk.
4. Fuses. See section 1.13.

# General information

## 1.7 Operational features

### 1. Lever A

For raising and lowering front-mounted attachments on the A-frame: (Picture 1)

- Top position: Raises the attachment.
- Middle position: Locks the attachment in a given position.
- Bottom position: Lowers the attachment.

### 2. Lever B

Activation of hydraulic connectors B1 and B2 – for attachments. (Picture 1)

- Pos. 1: Locked – oil flow activated = attachment operating.
- Pos. 0: Neutral (depends on the attachment).
- Pos. 2: The attachment operates in the reverse direction.

### 3. Lever C

Activation of hydraulic connectors C1 and C2 for rear-mounted attachments: (Pictures 1+2+3)

- Pos. 1: Raises/tilts the attachment (depends on the attachment).  
Lever C can be locked in pos. 1 by using the locking handle. This function must be used during work with the salt and sand spreader.
- Pos. 0: Neutral (depends on the attachment).

### 4. Lever D

Starts up attachments (depending on hydraulic connectors D1 and D2) (Picture 4)

- Pos. 1: Attachment operating.
- Pos. 0: Neutral – attachment stopped.
- Pos. 2: Attachment operating in the reverse direction (depends on the attachment).

Quick action coupling D3:  
Drain connection for various attachments (female – 1/4").

### 5. Speed regulation of attachments (defined by the attachment)

Regulates the oil flow in hydraulic connectors B and C.



#### Warning

Keep the quick action couplings clean of dirt.

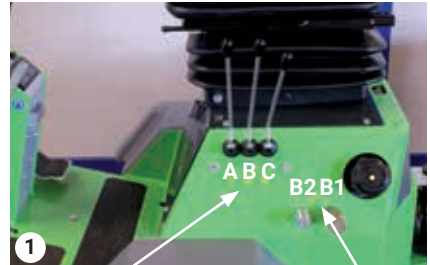

Levers A, B, C Hydraulic connectors B1, B2



Locking handle for lever C

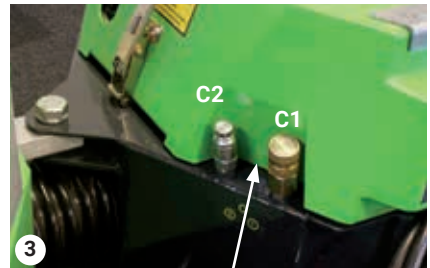

Hydraulic connectors C1, C2



Hydraulic connectors D1, D2, D3 Lever D Speed regulation

## 1.7 Operational features - continued

### Operation of attachments when the operator is not sitting in the driver's seat (exclusively for external vacuum hose)

- A) Park the basic machine and lock the parking brake.
- B) Keep the start button for attachment operation depressed while operating lever D. Start button must be pushed for min. 1. sec., for lever D to stay in. (Picture 1)

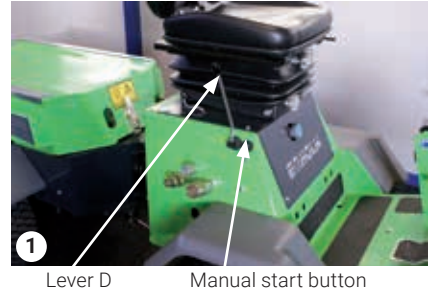

### 6. Parking brake

Activation of parking brake: press the brake pedal to its lowest position. The parking brake can then be slid forward. Release the brake pedal, and the utility machine is locked. (Picture 2)

### Attention

Due to the safety system the utility machine can only be left with the engine running if the handbrake is on. If you leave it with the engine running and the handbrake is off, the engine will stop within 2 sec.

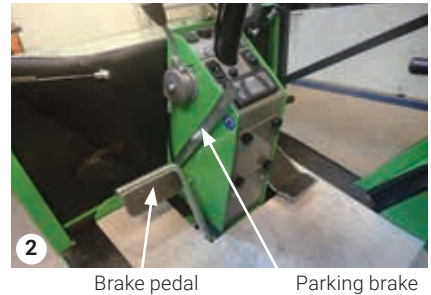

### 7. Brake pedal

Activated in its lowest position. (Picture 2)

### 8. Drive pedal

The drive pedal can only be activated when the brake pedal is in its highest position. The speed regulation is stepless.

- A) Drive forward: Press the pedal forward.
  - B) Reverse: Press the pedal backward.
- The pedal returns to its neutral position automatically.

To drive at full speed, push the throttle all the way forward. (Picture 3)

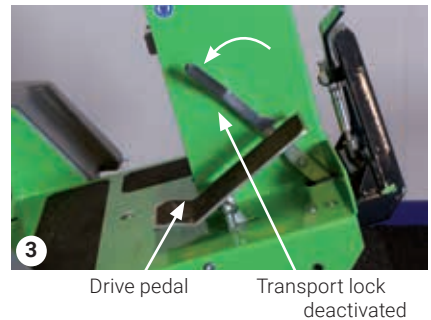

### 9. Transport lock

The transport lock must be deactivated when the utility machine is operating.

The transport lock must always be activated when the utility machine is being driven from one location to another.

The transport lock locks the A-frame in place so that the A-frame cannot be lowered during driving. (Picture 3+4)

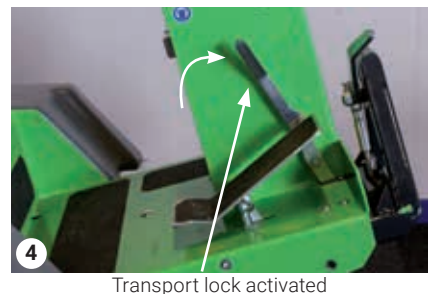

# General information

## 1.7 Operational features - continued

### 10. Towing lever

The towing lever under the machine is for moving the utility machine manually.

(Picture 1+2)

When the towing lever is in open position, the machine can be towed without starting the engine. The towing lever is in open position when the lever is horizontal.



#### Warning

When the towing lever is in open position, there is no powered steering!

The towing lever must be in closed position for the utility machine to be able to operate when the engine is started. The towing lever is in closed position when the lever is vertical.

The towing lever is fitted to the transmission pump and is located under the rear chassis of the Park Ranger 2150.

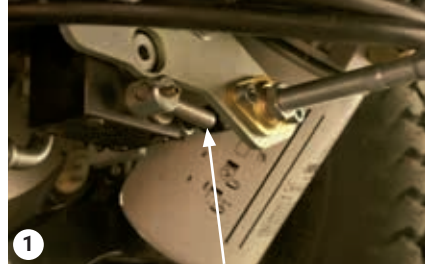

Towing lever open

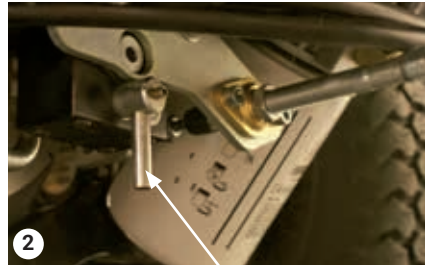

Towing lever closed

## 1.8 Fitting a cab (optional)

1. Remove the oil cooler cover. Lower the cab onto the utility machine (use a crane with a lifting strap that passes through the cab frame (Picture 1)). At the same time check the electrical cables from the cab and the waterhoses down towards the oil cooler. The electrical cable must be plugged in first.



1 Lowering the cab

2. Fasten the cab to the utility machine chassis using two M10 bolts at the front and two M8 bolts at the back. (Picture 2)



2 Fasten bolts

3. Connect the cab and the windscreen wiper to the electrical system of the utility machine. Remove the black cover on the right-hand side of the instrument panel, pull out the electric plug and connect it to the socket in the cab. (Picture 3)



3 Connection for windscreen wiper

4. Connect the hoses for the heating unit. Connect the two hoses from the cab to the two hose ends behind the oil cooler cover. (Picture 4)

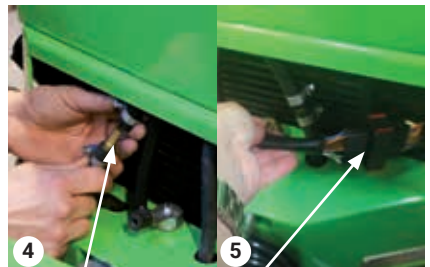

4 Hoses

5 Electrical cables

5. Connect the electrical cables. The electrical system of the utility machine is placed in the right-hand side, by the cooler. (Picture 5)

6. Fill coolant into the utility machine. Open the heat regulation system in the cab. Start the machine and let it run in neutral for 5 minutes. Stop the machine. Refill coolant, see Section 3.7.

# General information

## 1.9 Operating panel, cab (optional)

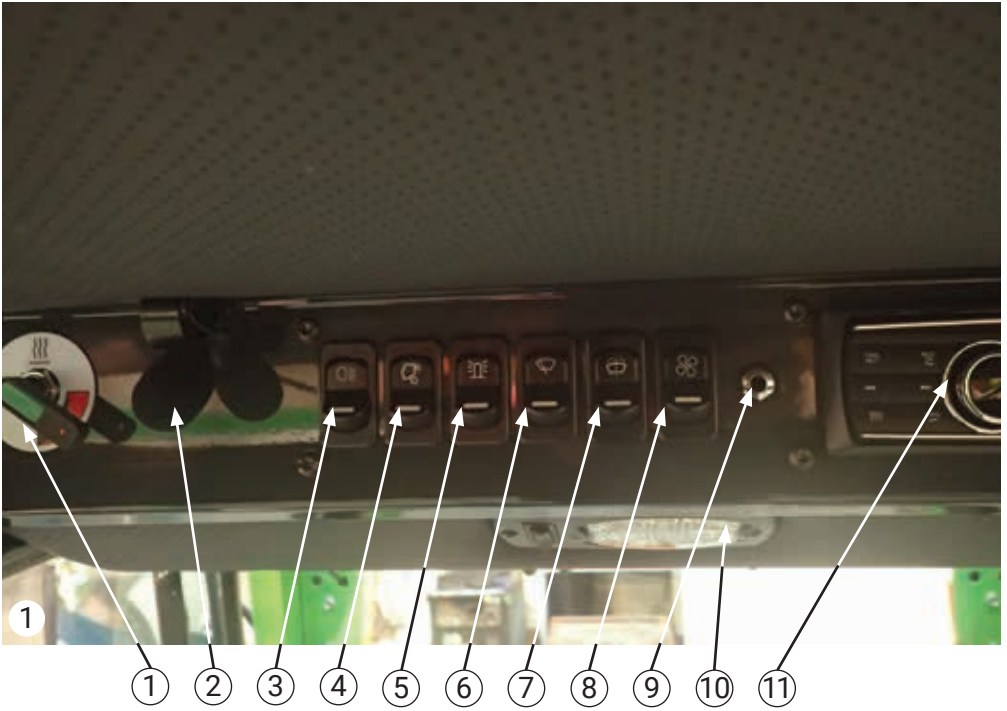

1. Heat regulation in the cab (for heat, turn on red).
2. Microphone for Bluetooth (see operator's manual for radio).
3. Light switch: Position 1. Parking lights.  
Position 2. Driving lights.
4. Work light, rear.
5. Rotary light.
6. Windscreen wipers: Wipe.
7. Windscreen wipers: Wipe.
8. Cab heater: Position 1. Half power.  
Position 2. Full power.
9. Plug for headphones.
10. Ceiling light: Position 1. White light.  
Position 2. Red light.
11. Radio (see operator's manual for radio).



# General information

## 1.10 Removable load carrier (optional)

### Removing the load carrier

A) Move the locking handle to "released" position. To do this, pull the handle out firmly while turning it to the right.

B) Pull the load carrier towards the back. (Picture 1)

### Fitting the load carrier

A) Fit the load carrier from the rear of the Park Ranger 2150. Push it into place so that it is seated in the locking handle on the frame. (Picture 2)

B) Pull the locking handle out and turn it to the left while the load carrier is pushed into position. (Picture 3)

C) Make sure that the locking handle is locked in position in the locking eye. Pull the load carrier to make sure that it is locked in position. (Picture 4)



Load carrier

Locking handle



Locking eye

Locking handle



Locking handle in "released" position



Locking handle in "released" position

# General information

## 1.11 Driver's seat

Adjust the seat to suit the driver.

Height: use lever 1 to adjust the height.

Weight: use lever 2 to adjust for weight.

Forward/back: use lever 3 to move the seat forward or back. (Picture 1)



Adjustment levers for the driver's seat

## 1.12 Oil cooler cover

### Removal

A) The oil cooler cover is removed downwards at an angle.

### Fitting

A) Insert the top edge of the oil cooler cover at an angle under the rim of the opening in the Park Ranger 2150. (Picture 2)

B) Push the oil cooler cover into position.



Fitting the oil cooler cover

# General information

## 1.13 Fuses and main switch

All fuses, apart from the main fuse in the Park Ranger are placed in the utility machine behind the cover at the steering wheel panel. To access these fuses remove 4 hand screws. (Picture 1+2)

### Main fuse

To access the main fuse, open the engine cover. The fuse (50 Amp) is located in the engine compartment below the exhaust pipe. (Picture 3)

### Main switch

To start the Park Ranger 2150, the main switch on the left-hand side of the machine must be ON. The main switch controls all power to the machine. (Picture 4)



Fuses in the steering wheel panel



Fuse overview - Back of the fusecover



Main fuse - 50 Amp

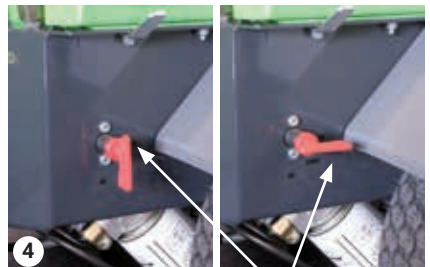

Main switch ON/OFF

# General information

## 1.14 Fuses and relay overview Fuse / relay overview in the steering column

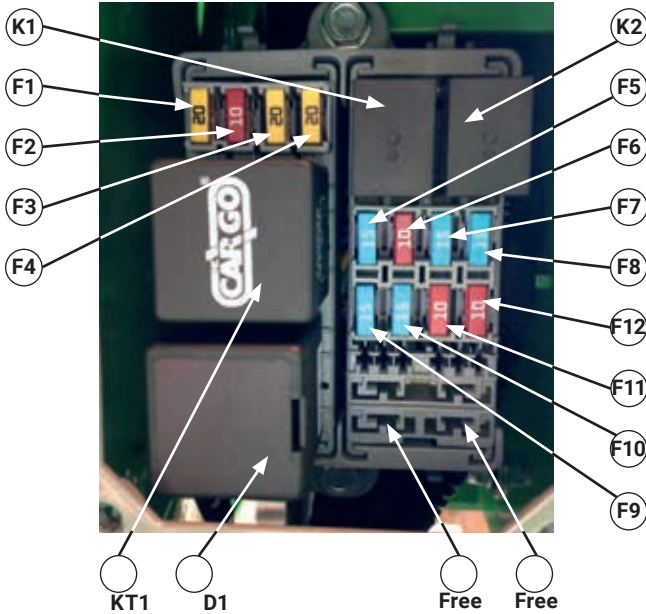

Fuse 1-4	K1	K2	KT1 Flash light
			D1 Flash light circuit
KT1	Fuse 5-12		K1 Hyd. level
			K2 alarm
D1	Free	Free	
<b>Fuse</b>	<b>Size</b>	<b>Function</b>	
F1	20A	Fan oilcooler / Fuel pump	
F2	10A	Safety circuit	
F3	20A	Plug for left side of the utility machine	
F4	20A	Plug for Snow V-blade	
F5	15A	Dipped headlights	
F6	10A	Supply flash	
F7	15A	Cabin fan / Trailer plug	
F8	15A	Rotary light / System for windscreen wiper	
F9	15A	Working light rear / Radio	
F10	15A	Parking light / Radio (emergency supply)	
F11	10A	Relay start	
F12	10A	Relay preheat control	

## 1.14 Fuses and relay overview - continued Relay placed below the driver's seat

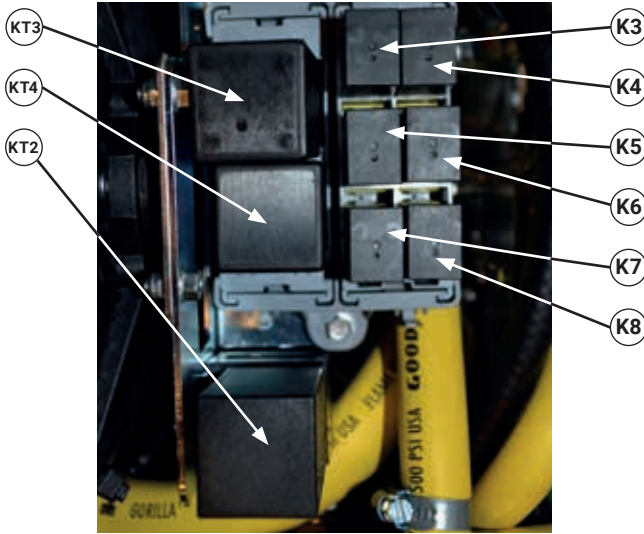

KT3	K3	K4	KT2 Preheat timer
			KT3 Seat timer
KT4	K5	K6	KT4 Impuls relay (intentional startup)
	K7	K8	K3 Anti startup
KT2			K4 Hot bulb timer feedback
			K5 Intentional startup (safty)
			K6 Intentional startup (safty)
			K7 Brake light
			K8 Lights

# Operator's manual

**Honest  
Machines**

## 2.1 Daily checks before start-up

### Before carrying out the daily checks, open the engine cover

A) It may be necessary to remove any rear mounted attachment. See the operator's manual for each attachment.

B) Remove the radiator cover. See Section 3.1.

C) Open the engine cover lock by pushing the locking button 1) down and then opening the catch 2).

D) Open the engine cover. (Picture 1)

### It is important to check the following before starting the machine

#### Hydraulic oil

Must be visible in the glass.

Filling – see "Maintenance", Section 3.4. (Picture 2)

#### Engine oil

The oil level must be between the two lines on the dipstick. Filling – see Section 3.5. (Picture 3)

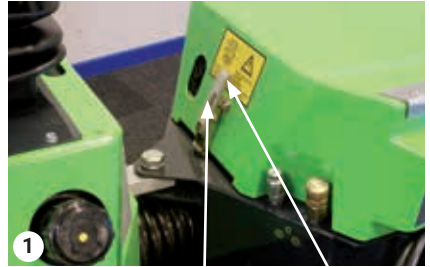

Cover lock    Locking button    Catch

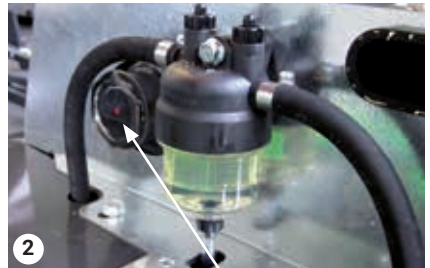

Hydraulic oil



Engine oil

# Operator's manual

## 2.1 Daily checks before start-up- continued

### Check the coolant

Remove the radiator cap and check that the fluid comes all the way up to the filling opening. (Picture 1)



### Warning

Never remove the radiator cap when the engine is hot. You may risk scalding or burns.

### Diesel oil

Tank capacity: 20 litres.

The control light comes on when 5 litres remain = sufficient for approx. 1½ hours.

This light can only work when the Park Ranger 2150 is switched on. (Picture 2+3)



Check coolant



Control light for diesel

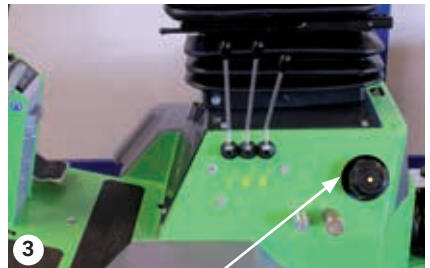

Topping up Diesel



## 2.2 Starting, operating and stopping

### The following conditions must be met before the engine can be started

- A) Make sure that control levers A, B, C and D are in position "0" (i.e. in the middle position). (Pictures 1+2)
- B) Make sure that the towing lever is in "closed" position. (Picture 3)
- C) Make sure that you (the driver) are sitting in the driver's seat. The Driver's seat is equipped with a mechanic switch that needs to be activated before you can start the machine.



#### Warning

If the handbrake is on it is possible to start the machine without anyone sitting on the driver's seat.

- D) Press the brake pedal (1) down to its lowest position and slide the parking brake (2) back. (Picture 4)
- E) Pull the throttle (3) approx. 1/4 of the distance.
- F) Turn the key (4) clockwise until the pre-heater indicator (5) lights up along with the other warning lights. When the pre-heater indicator goes out, turn the key farther clockwise and the Park Ranger 2150 will start.
- G) Release the brake pedal (1) to its top position.
- H) You can now activate the drive pedal(6).

Drive forward: Press the pedal forward.  
Reverse: Press the pedal backward.



#### Warning

Out of consideration for the hydraulic system, it is important that the machine reaches operating temperature BEFORE the engine is operated at full revolutions.



#### Warning

Turn the steering wheel carefully – the Park Ranger 2150 is articulated and the steering mechanism is extremely responsive.

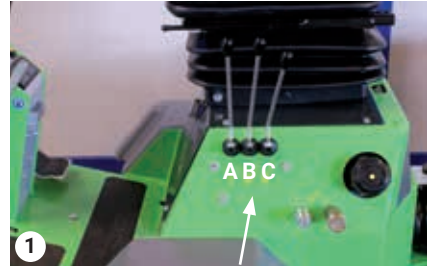

Levers A, B, C

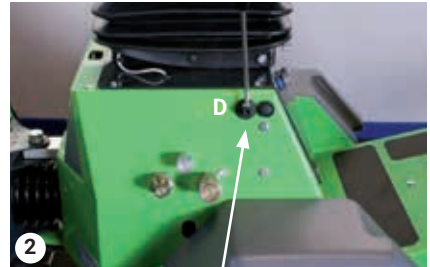

Lever D

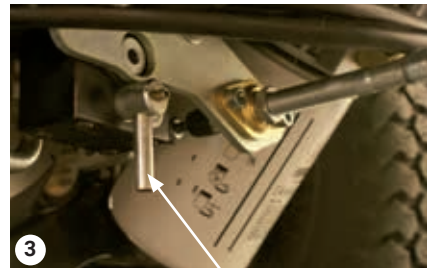

Towing lever in "closed" position

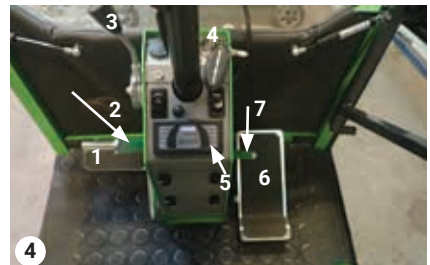

Operating controls

# Operator's manual

## 2.2 Starting, operating and stopping - continued

### Stopping the Park Ranger 2150

A) Make sure that control levers A, B, C and D are in position "0". (Picture 1+2)

B) Throttle (3) back so that the engine is running in neutral. (Picture 3)

C) Press the brake pedal (1) down to its lowest position and slide the parking brake (2) forward. (Picture 3)

D) Stop the Park Ranger 2150 by turning the key back to the starting position. (Picture 3)

### Operation with front-mounted attachments

If an attachment is fitted to the Park Ranger 2150, it must be raised above the ground before the machine is driven.

To lift the attachment, push lever A to the top position. Release lever A once the attachment has reached the appropriate height. (Picture 1)

For transport over long distances, the transport lock (7) must be activated. (Picture 4)

### Fitting attachments, front and rear

Please refer to the operator's manuals for the individual attachments.

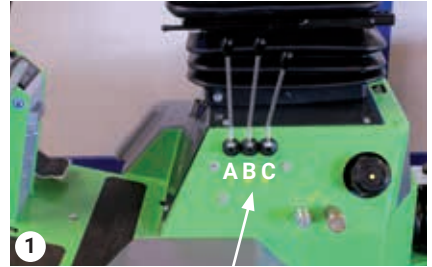

Levers A, B and C

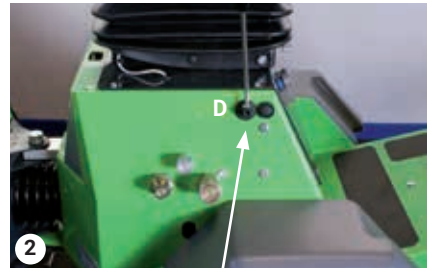

Lever D

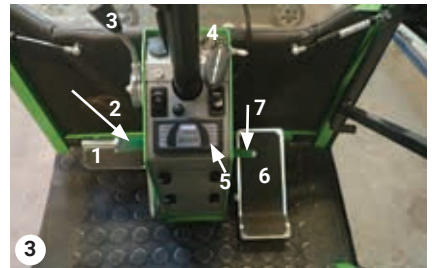

Operating controls

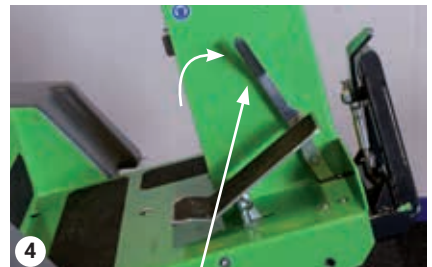

Transport lock activated

# **Service and maintenance**

**Honest  
Machines**

# Service and Maintenance

## 3.1 Daily maintenance

The daily maintenance of the Park Ranger 2150 is simple and straightforward – but very important. Three operations need to be performed: cleaning of the radiator, oil cooler and air filter.

### Cleaning the radiator

A) Remove the radiator cover by turning the two spring-loaded handles out to the side. (Picture 1)

B) Blow the radiator fins and the cover clean with compressed air.

C) The radiator fins can be washed with clean water.



#### Warning

Do not use hard implements when cleaning the body of the radiator, as this can damage the fins.

### Cleaning the oil cooler

A) Remove the oil cooler cover. (Picture 2)

B) Blow the cover and the cooler clean with compressed air.



#### Warning

The cooler must be cleaned with compressed air before the machine is washed, otherwise dirt will stick to it.

### Air filter housing and air filter element

Clean the air filter housing with a clean cloth, and blow the element clean from the inside with compressed air. (Picture 3+4)



1 Removing the radiator cover



2 Oil cooler cover



3 Loosen the filter housing



4 Remove the air filter element

# Service and Maintenance

## 3.2 Lubrication

### Lubricating nipples

Lubricate the lubricating nipples on the machine with one or two shots of good quality grease – every 15 hours or so.

There are two lubricating nipples by the A-frame, and four by the steering cylinders. (Picture 1+2)

### Cables and moving parts

Lubricate with a few drops of oil every 15 hours or so.

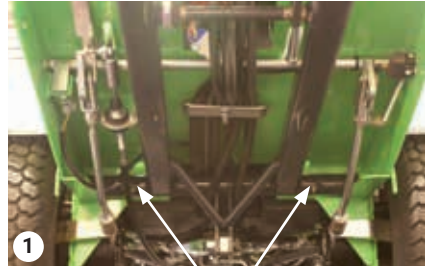

Lubricating nipples, A-frame

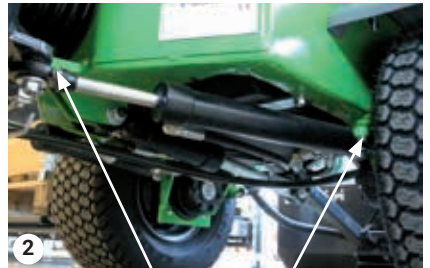

Lubricating nipples, steering cylinders

# Service and Maintenance

## 3.3 Park Ranger 2150 service and maintenance chart

X Lubricate

◆ Clean

● Replace

○ Check

Operation	Service schedule						
	Daily	First 50h	Every 400h	Every 800h	Every year	Every 2.year	See §
<b>Machine</b>							
Walk-around inspection	○						
Tyre Pressure (1)	○	○	○		○		
Wheel bolts (2)		○	○		○		
Battery		○	○		○	●	
Brakes		○	○/X		○/X		
Hydraulic connections (4)	◆	◆	◆		◆		
Lights	○	○	○		○		
<b>Engine</b>							
Air filter, main (3)	◆	●	●		●		
Air filter, safety (3)	◆	●	●		●		
Engine Oil	○	●	●		●		
Engine Oil filter		●	●		●		
Fuel filter	○	●	●		●		
Belt, Alternator		○	○	●	●		
Coolant	○	○	○		○	●	
Coolant hoses and collars		○	○		○		
Water Radiator (3)	◆	○	◆		◆		
Water Radiator pressure cap			○		○		
Cooling fan clearance			○		○		
Water temperatur sensor			○		○		
Engine mounts			○		○		
Air Intake pipe /clamp bands			○		○		
Fuel pipe / Clamps			○		○		
Hand throttle max rpm		○	○		○		
Pedal cable		○	○				
Hydraulic oil filter, transmission		●	●		●		
Valve Clearance				○			

# Service and Maintenance

## 3.3 City Ranger 2150 service and maintenance chart - continued

Operation	Service schedule						
	Daily	First 50h	Every 400h	Every 800h	Every year	Every 2.year	See §
<b>Hydraulic</b>							
Hydraulic oil	○	●	●		●		
Hydraulic oil filter, <b>return</b>		●	●		●		
Hydraulic oil cooler (3)	◆	○	◆		◆		
PTO pressure relief valve			○		○		
Hydraulic hoses		○	○		○		
<b>Lubrication</b>							
Steering cylinder left		X	X		X		
Steering cylinder right		X	X		X		
A-frame lift cylinder		X	X		X		

(1) See manual for correct pressure.

(2) Tightning torque.

(3) If the machine is operated in a very hot or dusty environment, more frequent service may be necessary.

(4) Clean all couplings with a clean cloth before mounting any attachment.

# Service and Maintenance

## 3.4 Hydraulic system

### Hydraulic oil

Check the level of hydraulic oil while the oil is cold.

The oil must be visible in the glass.

If there is no oil visible in the glass, refill the hydraulic oil tank. (Picture 1)



### Warning

Clean the area around the bleeding and filling spigot before removing the filler cap to prevent dirt entering the hydrostatic system, where it may cause damage.

### Refilling hydraulic oil

- Park the Park Ranger 2150 on a level surface.
- Put the handbrake on, turn off the engine, remove the radiator cover and open up the bonnet.
- Remove the bleeding and filling cap and pour in Texaco Rando HDZ 68 hydraulic oil. (Picture 2)
- Replace the cap and start the engine.
- Check that the oil fills  $\frac{3}{4}$  of the glass while the engine is running.
- Close bonnet and mount the radiator cover.

### Tank filter

Replace the filter and clean the housing during service procedures. (Picture 3)

### Hydraulic oil filter

- Remove the oil filter under the Park Ranger 2150 and let the oil run out until the tank is empty.
- Lubricate the gasket with oil.
- Fit the new filter.
- Pour in approx. 16 litres of Texaco Rando HDZ 68 oil. Check that the oil fills  $\frac{3}{4}$  of the glass. (Picture 4)



Bleeding/filling cap

Viewing glass



Tank filter



Tank filter housing



Hydraulic oil filter



## 3.5 Engine maintenance



### Warning

Always switch off the engine and turn off the main switch before checking the oil level and when changing the oil and the oil filter.

### Check the engine oil

1. Park the Park Ranger 2150 on a level surface.
2. Check the oil level before starting the engine. (Picture 1)
3. Pull out the dipstick, wipe it clean and then replace it.
4. Pull out the dipstick again and check whether there is sufficient oil in the engine.
5. The oil level must be between the two lines on the dipstick.
6. Add oil if the oil level is below the bottom line.
7. Always check to make sure that the oil level is correct.

### Filling with engine oil

1. Remove the oil cap. (Picture 2)
2. Pour in oil until the engine contains approx. 3 litres.
3. Wait approx. 5 minutes after pouring in the oil.
4. Then check the oil level again. It may take a little time for the oil to reach the oil pan.

### Changing the oil in the engine

Change the oil after the first 50 hours of operation. It is easiest to do this while the engine is warm.

1. Remove the bottom screw and let the old oil run out. (Picture 3)
2. Remember to replace the bottom screw!
3. Fill with new engine oil until the level reaches the top line on the dipstick. Approx. 3 litres of oil.



1 Check the oil level



2 Engine oil cap



3 Remove the bottom screw

# Service and Maintenance

## 3.5 Engine maintenance - continued

### Recommendations concerning oil

For the best engine performance, we recommend approved Perkins engine oils. Other high-quality oils may be used if they have one of the following API classifications: CF, CF-4, CG-4 or CH-4. Never use special additives.

### NB

Always ensure that the viscosity of the lubrication oil used matches the temperature range in the surroundings where the machine is operating. (Picture 1)

### Changing the engine oil filter

1. Use a filter spanner to remove the oil filter. (Picture 2)
2. Apply a thin layer of oil to the new filter gasket.
3. Fit the new filter by hand. DO NOT use a filter spanner, as this will over-tighten the filter.
4. Turn the engine on and let it run for a while to check that the filter seal is tight.
5. Switch off the engine and check the level of engine oil.
6. Add oil if the level of engine oil drops after the filter has been changed.

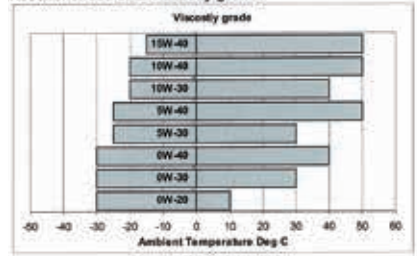

①

Oil types

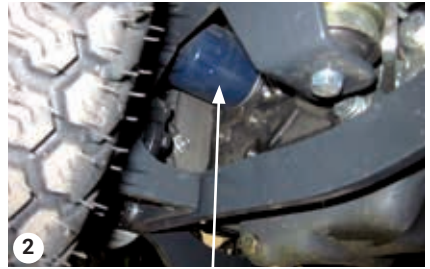

Engine oil filter

# Service and Maintenance

## 3.6 Fuel



### Warning

Always switch off the engine before filling up with fuel. Make sure there are no naked flames nearby because diesel oil is highly flammable.

### Fuel

ONLY use diesel as fuel. (Picture 1)

### Important when filling up with fuel

Make sure to keep the area free from dirt when filling up – dirt can cause problems in the injection pump. Do not let the engine run out of fuel, as this can create air bubbles in the fuel system.

### Cleaning and replacing the fuel filter

Always clean the filter in a clean area.

1. Unscrew the filter. (Picture 2)
2. Fit the new filter.
3. Bleed the fuel system.

### It is important to bleed the fuel system

1. When the fuel filter and hoses have been removed and then replaced.
2. If the engine has run out of fuel.

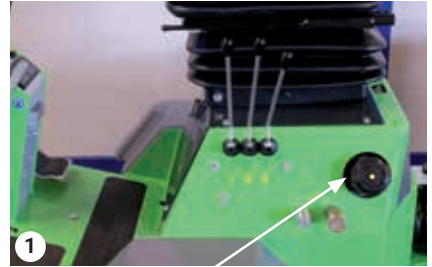

Diesel cap

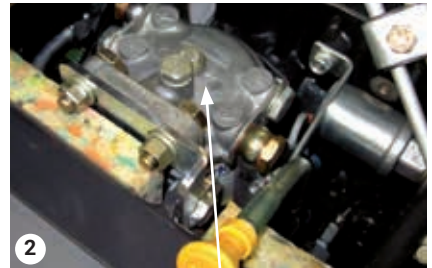

Fuel filter

# Service and Maintenance

## 3.6 Fuel - continued

### Bleeding the fuel system/the fuel filter

1. Switch on the machine to start the electric fuel pump.
2. Loosen the bleeding screw on the fuel filter. (Picture 1)
3. When fuel starts to run out, close the bleeding screw.
4. Turn the ignition key until the engine starts.

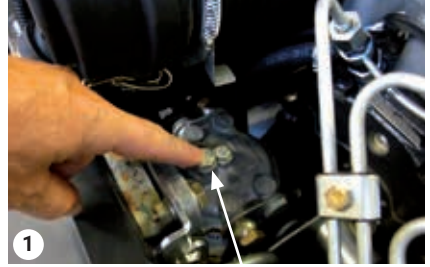

Bleeding screw on the fuel filter



#### Warning

Do not bleed the system while the engine is very hot. If fuel is spilled on a hot exhaust manifold, it can cause a fire.



#### Warning

Switch off the engine before checking or replacing fuel hoses. Damaged fuel hoses can cause a fire.

### Checking the fuel hoses during every service

1. Check for loose clips. Apply a little oil to the screw and tighten.
2. If any fuel hoses or clips appear worn, replace them immediately.
3. Bleed the fuel system after replacing hoses.

## 3.7 Radiator



### **Warning when removing the radiator cap**

Never remove the radiator cap while the engine is hot, as the hot coolant may spray out and cause serious burns. Wait to remove the radiator cap for at least 10 minutes after the engine has been switched off.

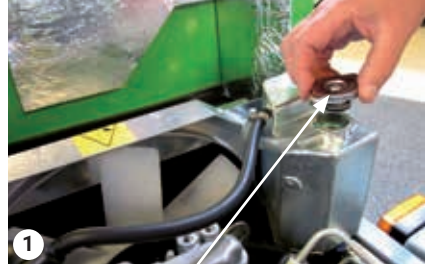

Coolant expansion container cap

### **Check the level of coolant every day**

A) Remove the radiator cap.

B) Check that the level of coolant reaches all the way up to the filling opening. (Picture 1)



### **Warning**

Always switch off the engine before filling up with coolant.

### **Filling coolant**

A) Remove the radiator cap and pour coolant into the expansion container so that the level of coolant reaches all the way up to the filling opening of the expansion container. Capacity: approx. 4 litres.

B) The coolant should consist of 50% pure water and 50% radiator fluid, or as described on the label on the packaging.

C) Replace the radiator cap carefully after filling up with coolant.

D) Start the Park Ranger 2150 and let it run until it reaches operating temperature.

E) Stop the engine and add coolant. (Picture 2)



Filling up with coolant

### **Check the radiator/cooler hoses**

Replace the hoses and clips every two years – or more often if they are damaged.

# Service and Maintenance

## 3.7 Radiator - continued

### Precautions against overheating

If the warning light illuminates, switch off all attachments immediately and let the engine run at half throttle. Clean the air intake grilles in the radiator cover (radiator cover can be removed for proper cleaning of the cooler) and try to identify the cause of the overheating. If you are in doubt about the cause, contact your nearest dealer. (Picture 1)



Radiator cover

### Cleaning the radiator

Clean the engine cooling system as described in section 3.1.

## 3.8 Air filter

### Cleaning the air filter

Open the vacuum valve every day to remove large particles of dirt and dust when the Park Ranger 2150 is being used in dusty environments.

A) Open the air filter housing.

B) Remove the filter unit.

C) Clean the air filter housing with a clean cloth.

D) Carefully blow the unit clean from the inside with compressed air.

E) Replace the filter unit and close the filter housing. (Pictures 2+3)



Air filter housing



Vacuum valve

## 3.9 Windscreen washer liquid

During winter, check that the windscreen washer liquid has frost protection properties.

A) The windscreen washer tank is in the cab, on the right side of the driver's seat.

B) To add windscreen liquid, unscrew the cap, add windscreen liquid and screw the filling cap on again. (Picture 4)



Windscreen washer liquid cap

## 3.10 Battery



### Warning

Always take the following precautions when removing the battery.

- A) Make sure the ignition and the main switch are switched off.
- B) Always remove the cable from the battery's negative (-) pole first.
- C) Make sure not to touch the two battery poles at the same time with any metal tools or object, and be careful to prevent the positive (+) pole from coming into contact with the machine. The short-circuit caused by this happening will generate sparks.
- D) Avoid sparks and naked flames. Do not smoke.
- E) When replacing the battery, always connect the positive (+) cable first and then the negative (-) cable.



### Warning

Both the explosive gases and the sulphuric acid that the battery contains can cause blindness and serious burns.

### Charging

Connect the positive (+) terminal of the charger to the positive (+) pole of the battery, and connect the negative (-) terminal to the negative (-) pole.

### Fluid level

A battery can be one of two types.

The first type of battery is maintenance free so no maintenance will be necessary.

The second type of battery is a battery where maintenance will be necessary.

Check the level once a year. Top up as necessary with ONLY demineralised water. (Picture 1)

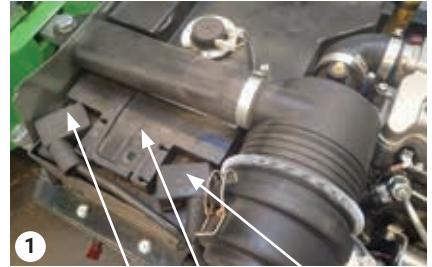

- pole      Battery      + pole

# Service and Maintenance

## 3.11 Fan belt

### Adjustment and tightening

An insufficiently tightened fan belt can result in the engine overheating and insufficient charging of the battery.

A) To check the tightness of the fan belt, press it in the middle with your finger. It should “give” approx. 7–9 mm (under 10 kg of pressure).

B) Also check the fan belt for cracks and tears. (Picture 1)

### Regulation of tension

Loosen the two bolts that hold the generator in place, and adjust its position to provide the necessary tension. Remember to retighten the nuts and bolts after adjustment.

## 3.12 Articulated joint

If there is any play in the articulated joint, the bearings need to be replaced.

To check for play, rock the front chassis. (Picture 2)

## 3.13 Towing

The Park Ranger is equipped with 2 towing points in front and 2 towing points at the rear. (Picture 3+4)

These towing points are also used for safe transport of the Park Ranger on trailers etc.



Fan belt



Articulated joint



Towing point - Front



Towing point - Rear



## 3.14 Tire change

When a tire needs changing the Park Ranger 2150 must only be lifted with a jack in the points indicated at picture 1+2.



### Warning

A tire change must be performed on a flat and stable ground only!

To perform a tire change you need following: a jack with a minimum lifting force of 500kg, a spare tire and a wheel wrench.

1. Place the jack either in the front or at the rear, depending on which tire you need to change.
2. When the jack is placed, loosen the tire bolts.
3. Then lift up the utility machine with the jack until it is possible to remove the old tire.
4. Change the tire and tighten the bolts with your hands.
5. Lower the jack and tighten the bolts once again with the wheel wrench.
6. Retighten the bolts again after 5-10 hours.

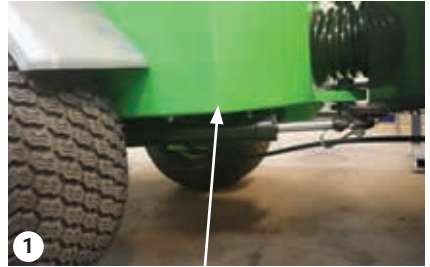

Jack lifting point - Front



Jack lifting point - Rear

# Conditions

**Honest  
Machines**

## 4.1 Warranty

The warranty period for the materials and manufacture of this Park Ranger 2150 is 12 months from the date of purchase.

In case of errors or defects on the machine within the warranty period, Egholm will carry out the necessary repairs at no charge to the customer, including materials and working hours, in accordance with the terms and conditions listed below.

### **The scope of warranty**

1. The Egholm warranty is only valid on presentation of the original receipt, supplied with model description, serial number and date of purchase.
2. Regular checks, adjustments, services and technical alterations are not covered by the warranty.
3. All inquiries concerning the warranty are to be addressed to the distributor from whom the machine was purchased.
4. This warranty does not cover faults and defects which cannot be traced back to defects in material or production errors.
5. This warranty is valid for persons who have legally acquired the machine within the warranty period.
6. In the event of failure to perform and substantiate service in accordance with the applicable instructions, Egholm reserves the right to reject any claim made within the warranty period.
7. Egholm reserves the right to make improvements and design-related alterations to the machine without being obliged to modify previously delivered models in relation hereto.

### **The warranty does not cover**

- Wear and tear, accidents, damage to the equipment caused by operating errors, negligence, changes to the construction of the machine or use of non-Egholm spare parts or attachments.
- Machines with illegible serial numbers.
- Damage caused by force majeure such as lightning, flood, fire, war, civil disturbance, etc. as well as damage resulting from incorrect or insufficient maintenance, consequential damage or other causes over which Egholm has no control.

# Conditions

## 4.2 Complaints

All inquiries regarding the machine should be made at the distributor from whom the machine was purchased. This applies to inquiries concerning normal use, service, maintenance and spare parts as well as any complaints.

We wish you many years of safe and satisfactory use of your machine.

Best regards  
Egholm A/S

## 4.3 Disposal

When, many years from now, your Park Ranger 2150 has reached the end of its working life, it should be disposed of in a responsible manner that conforms to relevant disposal regulations.

1. Used hydraulic oil, engine oil, diesel oil, coolant and AC coolant are to be delivered at an approved waste disposal facility or site.
2. Remove the plastic and rubber parts and dispose of them in accordance with the applicable environmental legislation.
3. After the parts mentioned have been removed, the machine is ready to be handed over to one of your local approved scrap merchants.

# Wearing parts

**Honest  
Machines**

# Wearing parts

## 5.1 Wearing parts – Park Ranger 2150



E01100250 Tyres and wheels



E90501643 Filter kit 2150



E01006500 Air filter



E01020020 Oil filter



E04003050 Hydraulic filter



E01020010 Fuel filter



E04003060 Hydraulic oil filter



E50000656 Fan belt 2150



E05001080 Bulb, main light



E05001050 Bulb, rotary light

# Wearing parts

## 5.1 Wearing parts – Park Ranger 2150 - continued



E04501200 Hydraulic connector, male, 1/4"



E05001090 Bulb, indicator switch



E04501220 Hydraulic connector, male 1/2"



E05001010 Bulb, indicator



E04501210 Hydraulic connector, male 3/8"



E05001040 Bulb, parking light, front



E04501230 Hydraulic connector, female, 1/4"



E04501240 Hydraulic connector, female, 3/8"



E04501250 Hydraulic connector, female 1/2"



E01006505 Safety element, air filter

# Notes





# Notes



# Honest Work.

**Egholm A/S**  
Transportvej 27  
7620 Lemvig, Denmark  
T.: +45 97 81 12 05  
[www.egholm.eu](http://www.egholm.eu) - [info@egholm.dk](mailto:info@egholm.dk)